

**Bearings and Services for
the Metal Industry**

SCHAEFFLER

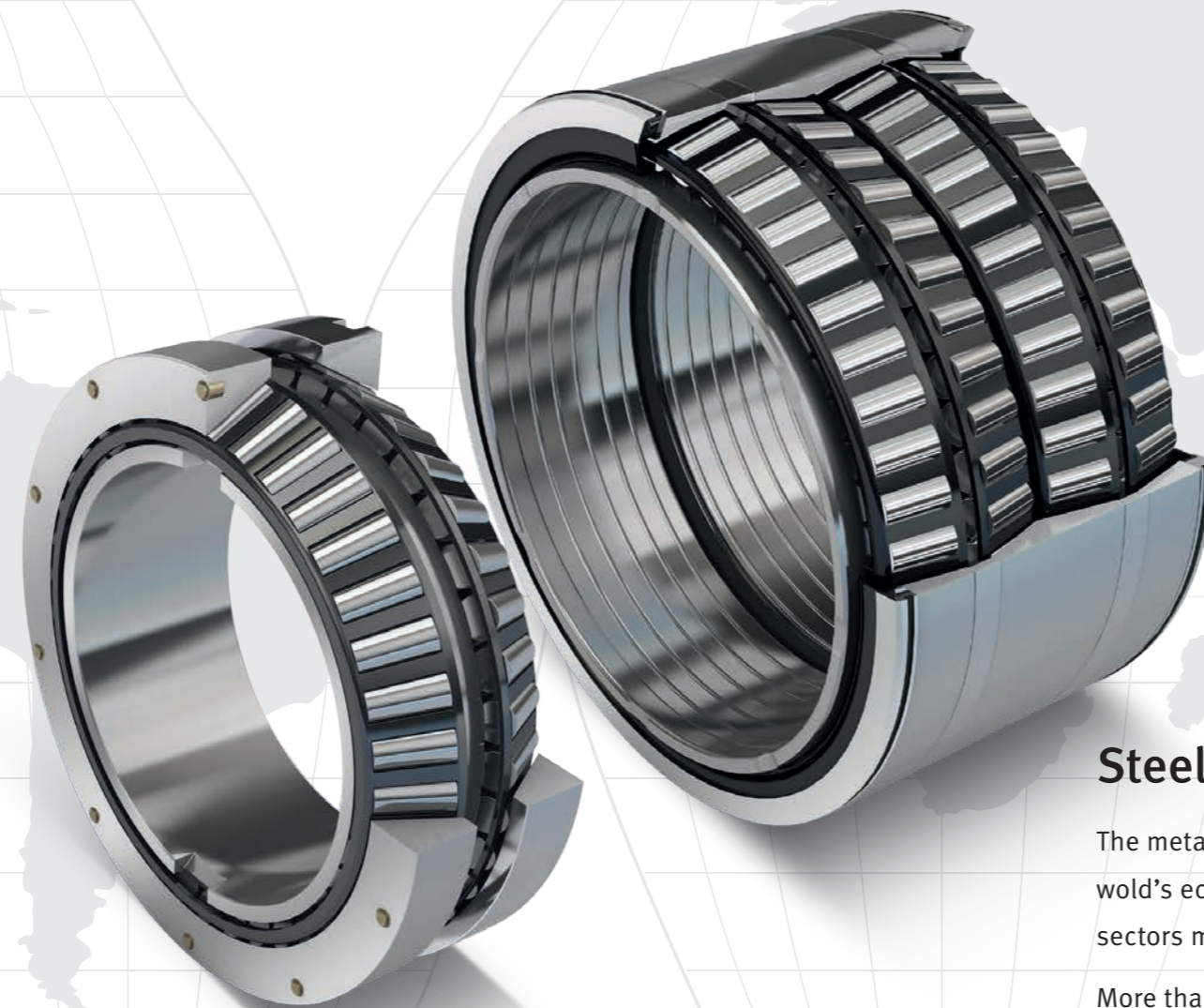

Steel shows great potential

The metal industry is an important driving force for the world's economy, and its close ties to other industrial sectors makes it indispensable.

More than one hundred years of experience in the rolling bearing business and a strong customer focus make Schaeffler with its INA and FAG brands an excellent choice as a partner to the metal industry.

Knowledge and experience ...



Schaeffler has its own competence group for equipping plants to produce and form steel and non-ferrous metals. Our specialists have been working together with plant manufacturers and operators for more than five decades and are therefore well versed in the processes and bearing positions. Hundreds of steelworks benefit from the quality of our customized solutions, which are efficient and safe and achieve ever-increasing production speeds while maintaining outstanding reliability.

High-performance and customer-oriented

- Complete product range for all metallurgical plant and rolling mill technology
- Application-specific bearing designs
- X-life premium products
- Optimized bearing, material, and seal combinations
- Products specifically designed for challenging and widely varying operating conditions
- Services for all rolling bearing products and applications, such as:
 - Expert support by experienced engineers
 - Optimum design of rolling bearings using the BEARINX calculation program
 - General and customer-specific training programs
 - Mounting and reconditioning of rolling bearings
 - Condition monitoring of rolling bearings during operation
 - Technical surveys at the operator's plant to identify TCO potential
 - Binding quality and environmental policy worldwide (ISO 9000/QS 9000, ISO/TS 16949:2002, ISO 14001)

... and a complete range of bearings and services



Spherical roller bearings



Bearing housings



Split spherical roller bearings



Spherical plain bearings with Elgoglide sliding layers

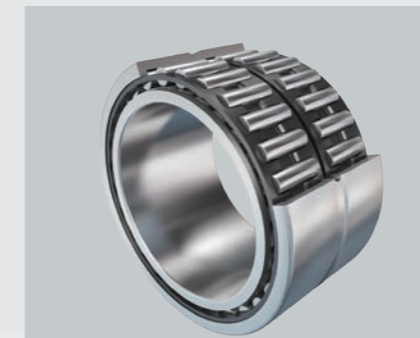

Needle roller bearings



Full complement cylindrical roller bearings

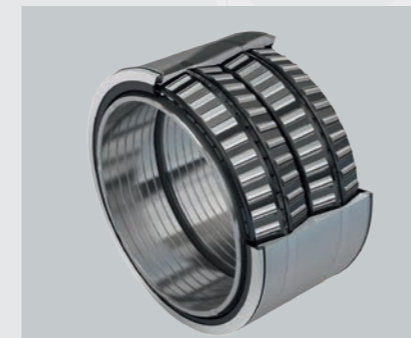

Four-row tapered roller bearings

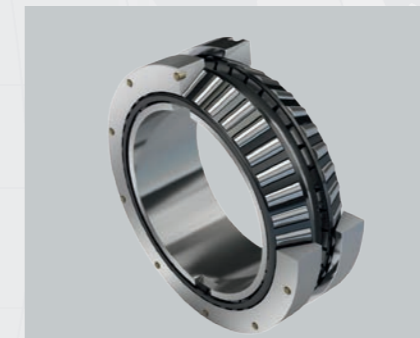

Double-row tapered roller bearings



Four-row cylindrical roller bearings

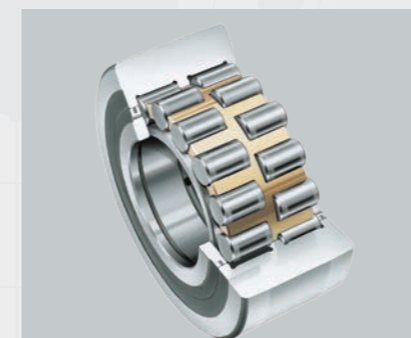

Backup rollers



Condition-oriented maintenance



Cost-effective reconditioning

Safe movement under extreme load and heat

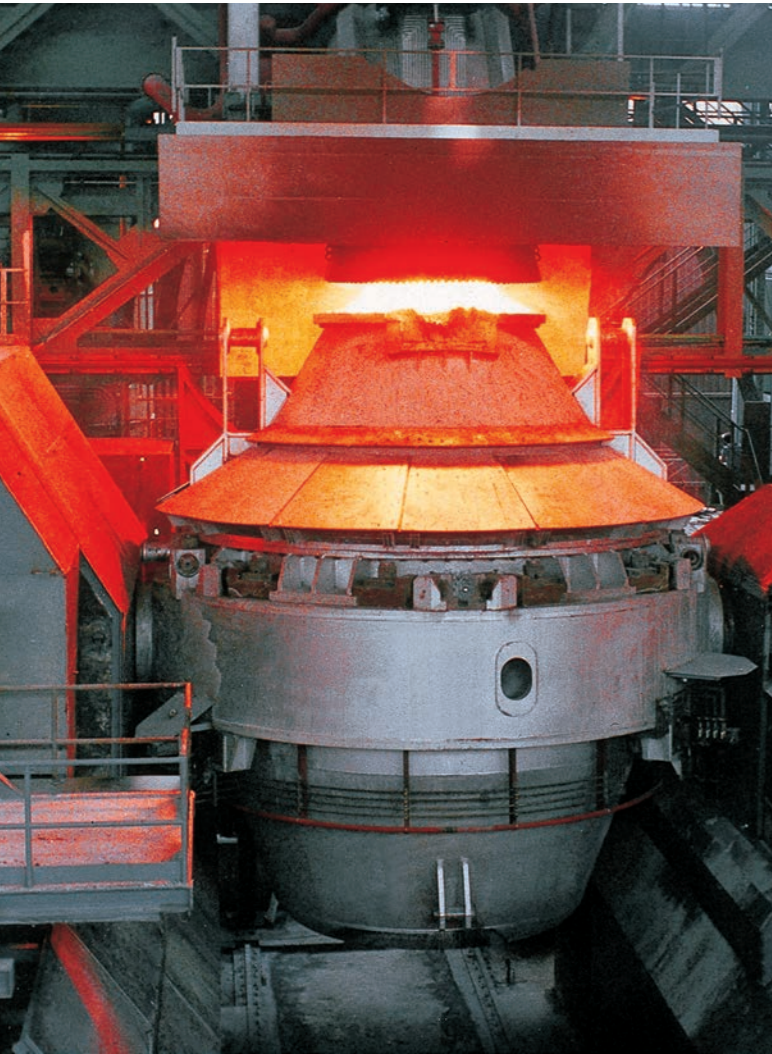

Converters

Converters are used to produce steel from pig iron. A full converter vessel can weigh up to 2,000 tons. Long-life plain bearings are used to support the vessel in a trunnion ring that is itself supported in the converter housing with a swivel facility for pouring. The swivel movement is carried out slowly under a large mass and high shock loads, so the bearings must have an extremely high static load carrying capacity. Misalignments and deformations in the structure must be compensated. For this application, we have developed robust spherical roller bearings with outside diameters of up to 1,750 mm that have proven successful in day-to-day operation in more than 200 converter systems around the world. The main gears in the gearbox are supported by FAG deep groove ball bearings or cylindrical roller bearings; bearing diameters of more than 2,000 mm are not unusual here.

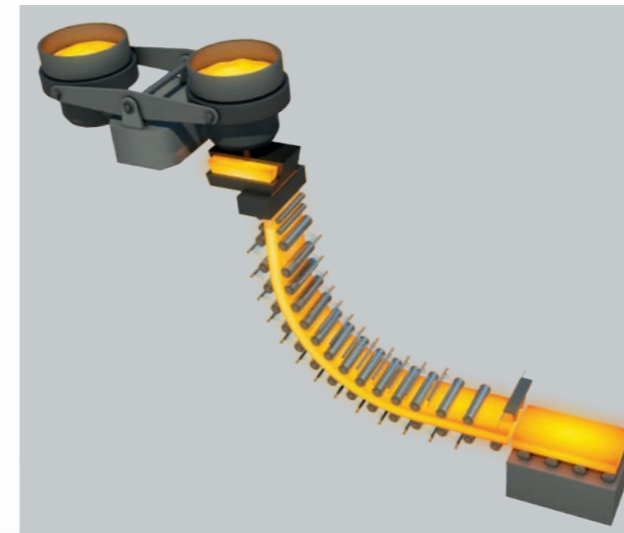
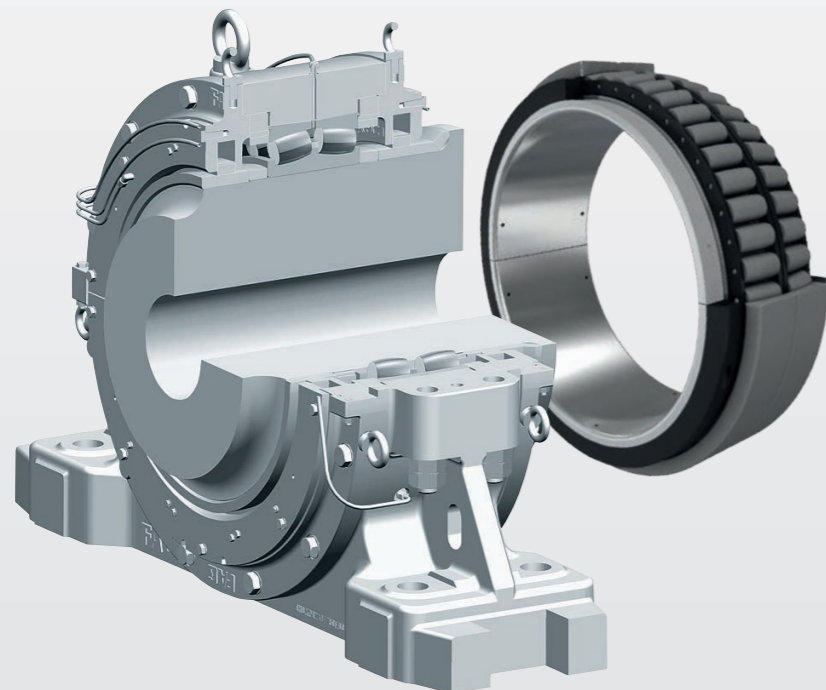

Ladle turrets

A ladle turret carries ladles between the casting position and the tapping position, thus ensuring smooth operation of the continuous casting plant. The bearing supports are continually subjected to high loads as well as abrupt shocks and tilting moments. The cylindrical roller bearings, axial spherical roller bearings, and spherical plain bearings are designed specifically for these loads.

Continuous casting plants

In this essential forming process, steel is continuously cast through a mold to form a strand. During the cooling phase, the strand is transported and supported by slowly rotating rollers. The bearing supports for the rollers must function reliably – under high loads, at high temperatures, and when subjected to water spray. With its CoCaB



(Continuous Caster Bearing) program, Schaeffler offers bearing solutions that are perfectly tailored to the requirements of continuous casting plants: INA machined needle roller bearings, FAG spherical roller bearings, cylindrical roller bearings (open or sealed versions), bearing housings with cooling water circulation, and split spherical and cylindrical roller bearings for locations that are difficult to access. Sealed bearings allow the grease volume to be reduced by as much as 80%. Without doubt a highlight of our CoCaB range is the ideal non-locating bearing solution – the full complement cylindrical roller bearing:

- Extremely high radial load carrying capacity
- Axial displacement without constraining forces
- Capable of compensating angular misalignments
- Simple and quick to mount



Maintenance-free spherical plain bearings with ELGOGLIDE



Robust needle roller bearings in X-life quality



Sealed spherical roller bearings



Full complement cylindrical roller bearing with an angular adjustment facility

Designed for smooth production

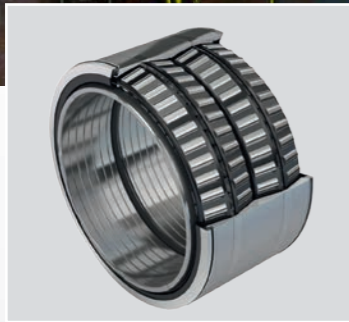
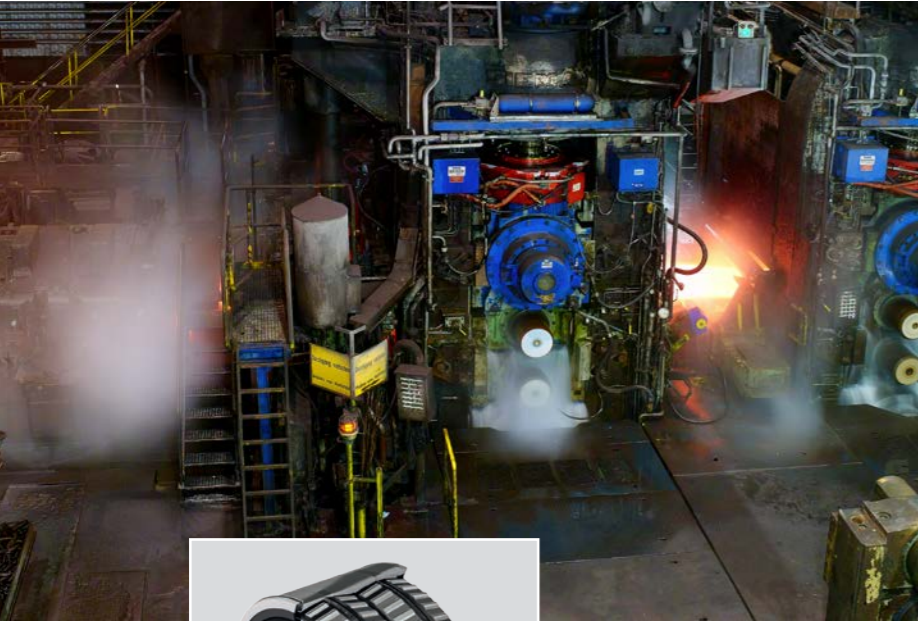

Multi-row tapered roller bearings in hot rolling stands

Hot rolling

Hot rolling is carried out above the re-crystallization temperature of the rolling stock. Depending on the product, a distinction is made between plate, hot strip, section, bar, and wire mills. The angular adjustment of the chocks in rolling mills allows the use of four-row tapered roller bearings and multi-row cylindrical roller bearings as radial bearings. The design of the radial bearings depends on the application: Angular contact ball bearings for rapidly rotating rolls under low axial load, double-row tapered roller bearings and axial spherical roller bearings for bearing locations subjected to high axial loads.

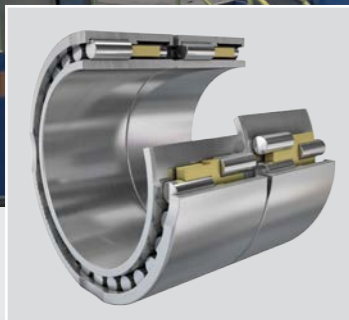

Multi-row cylindrical roller bearings in cold rolling stands

Cold rolling

In the cold rolling process, cold strip is generally shaped without prior heating. In comparison with the hot rolling process, higher dimensional accuracy and surface quality together with smaller sheet thicknesses are achieved. Four-row FAG cylindrical roller bearings in version F12 fulfill the high demand for precision, even in high-speed rolling mills for aluminum. In multi-roll mills for stock that is difficult to roll, cylindrical roller bearings are used as back-up roller systems and ensure uniform sheet thickness and surface quality under extremely high loads.

... and for other applications

For the exceptional demands of rolling mills as well as downstream plants and processes for the further processing of rolled stock, we have developed a wide range of application-specific solutions in close partnership with our customers.



Wire rod block and laying head with special cylindrical roller bearings, angular contact ball bearings, and spindle bearings



Coiler with tapered roller bearings and cylindrical roller bearings



Cold pilger machine for rolling seamless tubes with special spherical roller bearings



Rolling mill gearbox with tapered roller bearings and cylindrical roller bearings

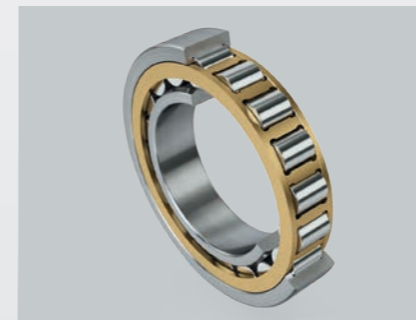

Single-row cylindrical roller bearings



Spherical roller bearing



Double-row tapered roller bearings

Services for all products and applications

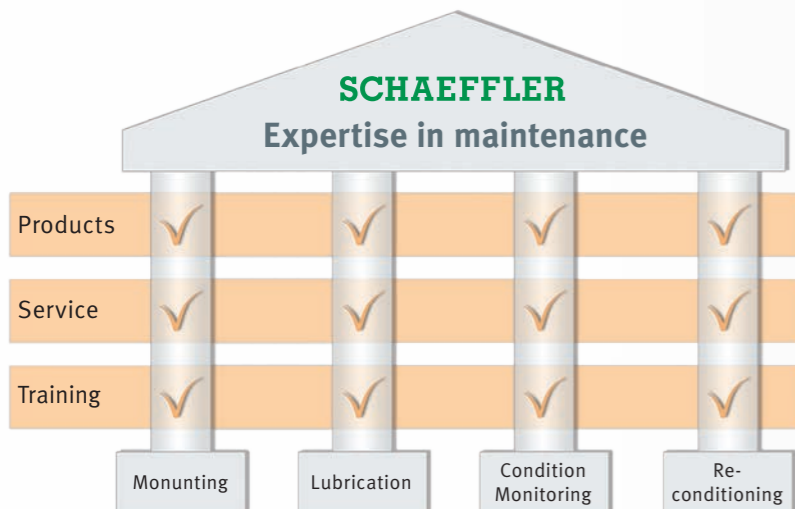

Capital-intensive production facilities require permanent availability, which is provided by top-quality equipment and an intelligent lifecycle service that leaves nothing to chance. For rolling bearings operating under particularly wear-intensive conditions, this means that reliable products and services for mounting, lubrication, condition monitoring, and reconditioning of rolling bearings are required. This is exactly where Schaeffler is the partner for you. Our portfolio of maintenance and quality assurance services ranges from installation and plant monitoring through to the introduction and implementation of preventive maintenance measures. The reconditioning of rolling bearings, for instance, another service offered by Schaeffler, ensures short delivery times and thus makes a decisive contribution to ensuring the perma-

nent availability of plants and machinery. A wide range of mounting and alignment tools, gauges, and lubricants – in addition to our training program – facilitates maintenance work and helps design work processes more efficiently.

Thanks to many years of experience and highly qualified specialists, Schaeffler is the expert partner for customer-focused solutions covering all aspects of the rolling bearing lifecycle. Schaeffler now offers OEMs and plant operators specific Industry 4.0 solution packages for optimizing processes and increasing the availability of machines and equipment. This includes condition monitoring by remote diagnosis for significantly increasing machine availability. In addition to conventional plant monitoring, the FAG DTECT X15 system helps ensure consistent rolling stock quality (chatter mark detection). Schaeffler also offers a broad range of mechatronic components and digital services.

Fast and flexible

Customized monitoring systems detect damage or changes in the condition of equipment at a very early stage. This increases planning security: Unplanned downtimes are prevented, and bearing replacement can be arranged in advance. Schaeffler supports steel production worldwide with state-of-the-art technology. If personal intervention is required, our highly qualified technicians and engineers are on hand to provide fast, competent help on site. Excellent security is ensured by service contracts with scope and terms designed to match the plant, the operating conditions, and above all, the customer requirements. We will be happy to provide you with further information.

www.schaeffler.de/en/service

www.schaeffler.de/en/maintenanceproducts

Application and design with practice-oriented software

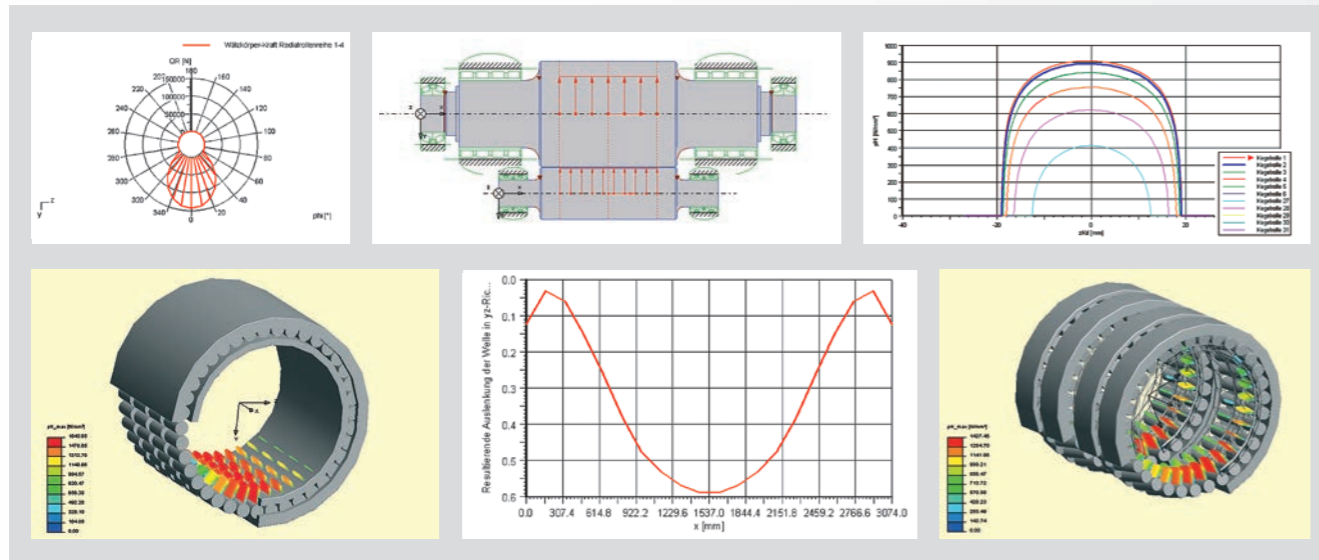

BEARINX

The BEARINX software can be used, for example, to calculate the bending behavior of elastically supported rolls under any desired load. The support reactions, the internal loads in the rolling bearings, the comparative stresses of the shafts, and the most important key values are presented in numeric and diagrammatic form. BEARINX takes account of:

- The elasticity of smooth and stepped rolls, both hollow and solid, made from various materials and their transverse force deformation
- Shaft loads resulting from rolling forces and bending moments or from the external forces acting on the bearings
- Shaft support by rolling bearings without linear spring support, including: Bearing geometry, bearing clearance, rolling element and raceway profiles, and special conditions in loading are included
- Any number of load cases

Results that can be documented:

- Deflection and inclination of the roll axis at freely selectable locations
- Curves for transverse force and bending moments
- Stresses, bearing reaction forces, and bearing deflection

- Load conditions of the individual rolling elements
- Pressure distribution in the rolling contacts of the individual rolling elements
- Parameter analyses of all input variables

In the calculation of fatigue life, the actual loads in the rolling contact calculated with BEARINX are taken into account.

medias professional

Our electronic consultation and selection system *medias professional* provides information on more than 40,000 standard products for approximately 60 industrial sectors. It additionally includes:

- Detailed product information
- Comprehensive design and safety tips
- Details on bearing design
- Representative mounting examples
- CAD downloads
- Tables showing accuracies, tolerances, and bearing clearance
- Bearing seals

You can find the *medias* product catalog on the internet at: <http://medias.schaeffler.com>

Products and services from one source

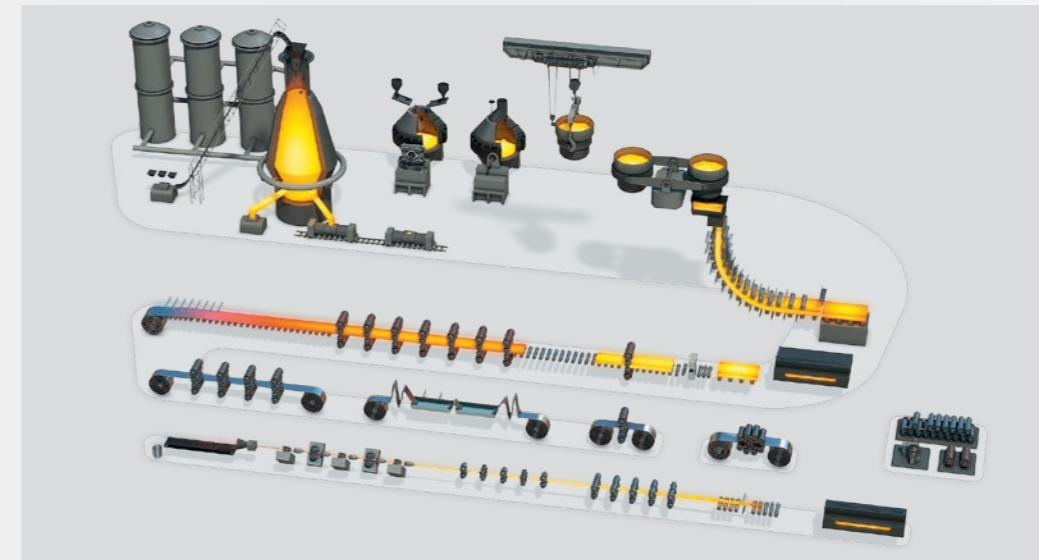

Schaeffler has expert knowledge of bearing technology, comprehensive expertise in metallurgical plant and rolling mill applications, and many years of experience in working with the steel industry. With the focus on maximum availability and quality, original equipment manufacturers and plant operators are offered a complete range with comprehensive service:

- Expert technical consultation, bearing design, and product recommendations
- Complete bearing product range
- Customer support when mounting bearings through

mounting instructions, training courses, and experienced service personnel

- Comprehensive service consultation before and after purchase
- Condition monitoring of bearing supports with remote diagnosis
- Worldwide presence and rapid active assistance in all regions

For further information, visit:

<http://schaeffler-fairs.de/stahlwerk>

X-life — proven to be better

X-life is a seal of quality for particularly high-performance products from Schaeffler's INA and FAG brands. X-life products are characterized by higher dynamic load ratings compared to the existing standard. They make new designs possible:

- X-life increases the rating life of the bearing support under the same loads and in the same design envelope
- Alternatively, an X-life bearing can support higher loads in the same design envelope and with the same rating life
- If the rating life and the loads remain unchanged, X-life bearings allow per-

formance to be improved, the design envelope to be optimized, and weight to be reduced

X-life therefore makes a significant contribution to increasing the overall efficiency of our customers' applications.



Global expertise – local knowledge – optimum performance for the customer



Schaeffler has been a renowned development partner for the metal industry for many years. This is not least due to our excellent product quality and strong individual customer support. At the same time, our thinking is consistently global: You can find our engineering expertise at a location near you virtually anywhere in the world.

Schaeffler Global Technology Network – a strong network for your success

With the Global Technology Network, Schaeffler combines its local expertise in each region with the knowledge and innovative strength of its experts around the world under

one roof. Our local centers of expertise – “Schaeffler Technology Centers” – let us offer our engineering and service expertise close to you. This combination provides you with optimum support anywhere in the world and our consolidated expertise brings you innovative, customized solutions of the highest quality.

Benefit from our engineers' experience and expertise! Locally, anywhere in the world. Find out more about the GTN: www.global-technology-network.com

www.schaeffler.de/en

Schaeffler Technologies AG & Co. KG

Georg-Schäfer-Strasse 30

97421 Schweinfurt

Germany

Internet www.schaeffler.de/en

E-Mail info@schaeffler.com

In Germany:

Phone 0180 5003872

Fax 0180 5003873

From other countries:

Phone +49 9721 91-0

Fax +49 9721 91-3435

Every care has been taken to ensure the correctness of the information in this publication. However, no liability can be assumed for any errors or omissions.

We reserve the right to make technical changes.

© Schaeffler Technologies AG & Co. KG

Issue: December 2018

This publication or parts thereof may not be reproduced without our permission